

DIMMER CONTROLS



DIMMER 1 CHANNEL



DIMMER 2 CHANNEL



**DIMMER 5 CHANNEL
(COMING SOON)**

DESCRIPTION:

Bromic Heating's new Dimmer Controls give customers customized control over heating output. These units require a smart device with internet connectivity, as well as the Bromic Smart-Heat App which is available on the App Store and Google Play Store.

The base models provide both Bluetooth and Wi-fi communication capabilities for Bromic App control. The 5 channel controllers include options for ethernet connectivity or BMS integration via 0-10 VDC built-in, whereas these features can be added to the 1 & 2 CH controllers via an optional expansion board.

The Smart-Heat Control operates using a smart device with a Bluetooth or Wi-Fi connection. The mounting location of the Smart-Heat Control must be selected to ensure that it is within range for the selected communication method. Refer to Installation Manual for mounting location requirements.

The Bromic Smart-Heat App is available on the App Store and Google Play Store.

DIMENSIONS:

*Dimensions shown in mm (inches)

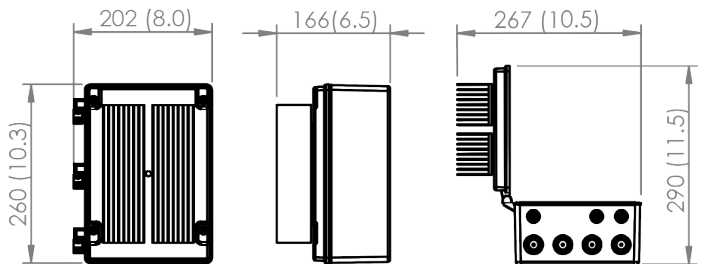

DIMMER 1 & 2 CHANNEL

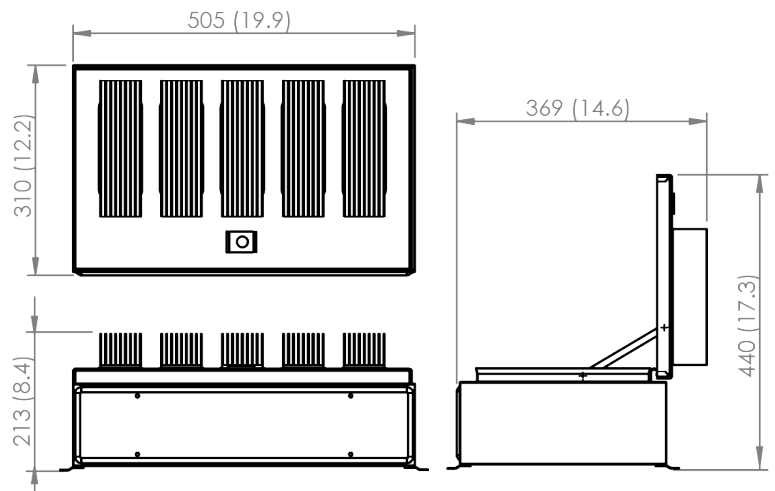

DIMMER 5 CHANNEL

CLEARANCES

Allow sufficient clearance for cabling.

*Clearances shown in mm (inches)

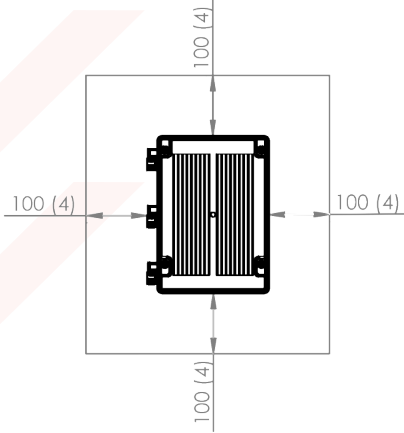

DIMMER 1 & 2 CHANNEL

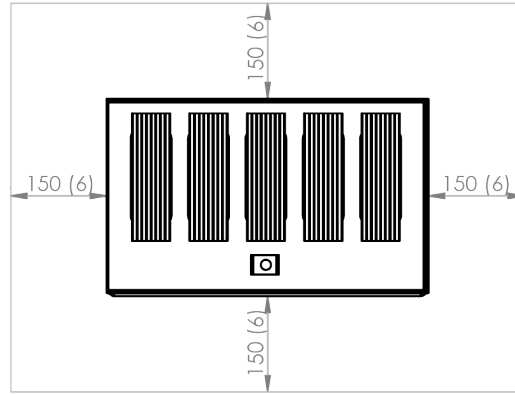

DIMMER 5 CHANNEL

MOUNTING OPTIONS:

Mounting is required at 6' mounting height for all Dimmer controls. Location should be selected to avoid accidental contact.

Wall Mounting

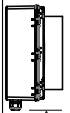

Dimmer (Heat Sink) models only
Minimum 1.8m (6')



Suitable for all Dimmer models.

Ceiling Mounting

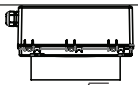

Dimmer (Heat Sink) models only
Minimum 1.8m (6')

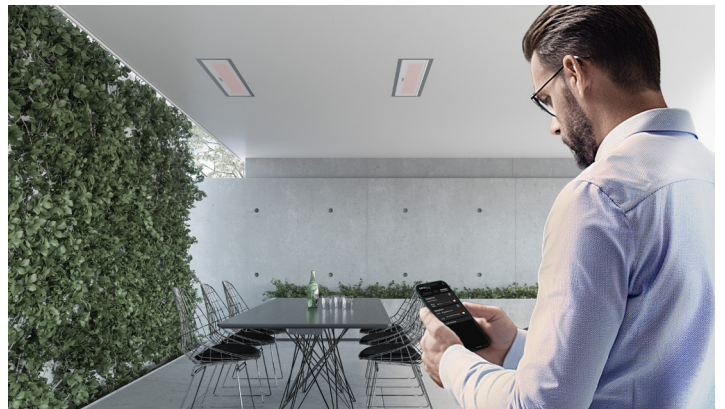

Suitable for only the Dimmer Channel 1 & 2 models.

PRODUCT SPECIFICATIONS

Model	Smart-Heat Control Dimmer1CH	Smart-Heat Control Dimmer 2 CH	Smart-Heat Control Dimmer 5 CH
Part Number	BH3130061	BH3130062	BH3130063
Number of Channels	1	2	5
Voltage - Max Capacity Per Channel	220-240V - 6kW	220-240V - 6kW	3N- 220/380V - 6kW 3N- 230/400V - 6kW 3N- 240/415V - 6kW 3N- 277/480V - 6kW
Operating Temperature Range	-20°C to +30°C	-20°C to +30°C	-20°C to +30°C
Non-Operating Temperature Range	-30°C to +70°C	-30°C to +70°C	-30°C to +70°C
Protection Rating	IP54	IP54	IP54
Dimensions	290 x 202 x 163mm	290 x 202 x 163mm	500 x 340 x 252mm
Weight	1.6kg	2.4kg	12.5kg

This equipment complies with EN/IEC 61000-3-11. For more information including mounting requirements, wiring diagrams and controller clearances, please refer to the Installation Manual.

OPTIONAL ACCESSORY

Bromic's Expansion Board accessory option for the 1 and 2 channel On/Off and Dimmer controls, allows for seamless ethernet integration for a full-proof connection to your outdoor heaters managed via the Bromic Heating app. Additional 0-10V connections allow for seamless plug and play to your Home Automation System or Business Management System.

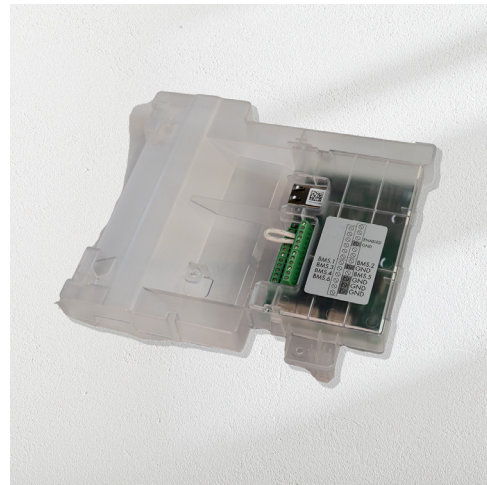

SCAN TO LEARN
MORE ABOUT
OUR CONTROLS



SCAN TO LEARN
MORE ABOUT
OUR APP

BROMIC
HEATING